



GLASSCRAFTERS INC.

GLASSCRAFTERS, INC  
11 York Avenue, West Caldwell, NJ 07006

1+(800) 233-7362 (F) 1+(888) 233-7362  
sales@glasscraftersinc.com

# Mirrored Cabinet Accessories

## for Customized Storage and Enhanced Functionality

The following instruction sheet is for the installation of these models: GCMCA-04-01, GCMCA-06-01

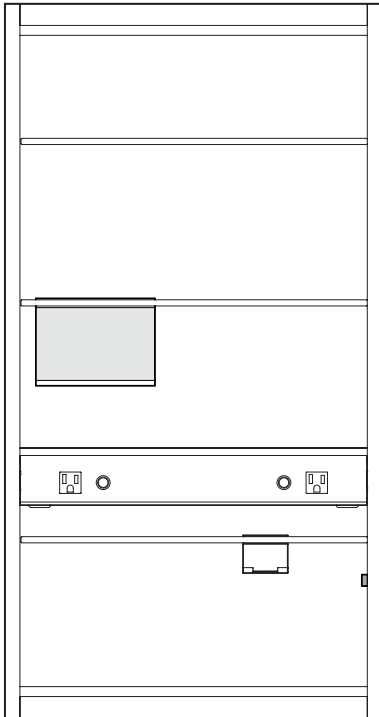

Example of accessory placement

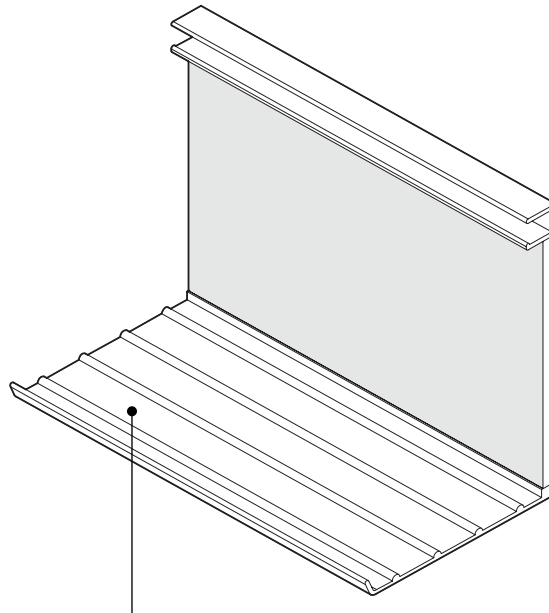

### Cosmetic Shelf Accessory

- Eyeliner Pencils
- Brushes
- Mascara Containers

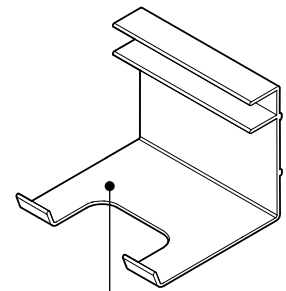

### Razor Holder

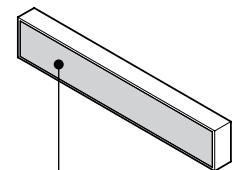

### Magnet

- Tweezers
- Clippers

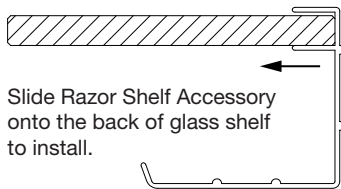

Slide Razor Shelf Accessory onto the back of glass shelf to install.

(Side View)

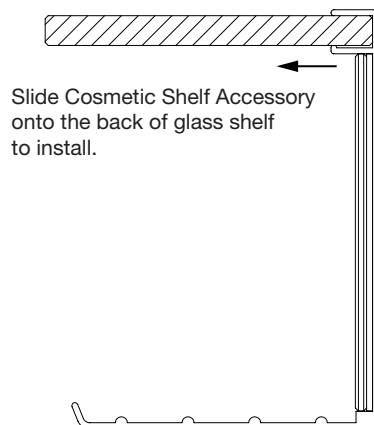

Slide Cosmetic Shelf Accessory onto the back of glass shelf to install.

(Side View)

### INSTALL LAST

After glass shelves are installed, use available shelf pin holes to identify location. Remove adhesive tape backing and push Magnet Accessory into open shelf pin holes on side wall of cabinet to install.

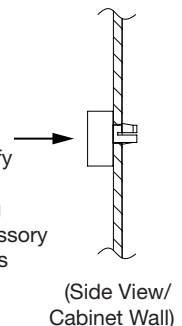

(Side View/  
Cabinet Wall)

**NOTE:** Magnet Accessory **cannot** be repositioned after being installed.

**SAVE THESE INSTRUCTIONS  
FOR FUTURE REFERENCE**

Please use extreme care while unpacking and handling your GlassCrafters' Mirrored Cabinet Accessories. Report any damage immediately to our GlassCrafters' customer service team at 800-233-7362, Monday thru Friday from 8:00 am to 5:00 pm (EST).

Revised 10/2019